

**VTECH**®

27100

# LITTLE Learning Pal™

**USER'S MANUAL**



© VTECH

Printed in china

91-01214-000 美 L

**Dear Parent:**

*At VTech® we know that children have the ability to do great things. That's why all of our electronic learning products are uniquely designed to develop a child's mind and allow them to learn to the best of their ability. Whether it's learning about letters, numbers, geography or algebra, all VTech® learning products incorporate advanced technologies and extensive curriculum to encourage children of all ages to reach their potential.*

*When it comes to providing interactive products that enlighten, entertain and develop minds, at VTech® we see the potential in every child.*

# INDEX

<b>INTRODUCTION</b> .....	<b>1</b>
<b>POWER SOURCE</b> .....	<b>1</b>
<i>BATTERY INSTALLATION</i> .....	<b>2</b>
<b>TURNING THE UNIT ON</b> .....	<b>2</b>
<b>TURNING THE UNIT OFF</b> .....	<b>2</b>
<b>AUTOMATIC SHUT-OFF</b> .....	<b>3</b>
<b>CARD STORAGE</b> .....	<b>3</b>
<b>KEYBOARD DESCRIPTION AND FUNCTIONS</b> .....	<b>4-5</b>
<b>SCORING</b> .....	<b>6</b>
<b>LITTLE LEARNING PAL™ ACTIVITY CARDS</b> .....	<b>6</b>
<i>DESCRIPTION OF CARD ACTIVITIES</i> .....	<b>6-9</b>
<b>8 ON BOARD ACTIVITIES DESCRIPTION</b> .....	<b>10-12</b>
<b>HOW TO USE THE MATCHBOOK</b> .....	<b>12</b>
<b>CARE AND MAINTENANCE</b> .....	<b>12</b>

# INTRODUCTION

Thank you for purchasing the **VTECH® Little Learning Pal™** learning unit. We at **VTECH®** are committed to providing the best possible products to entertain and educate your child. Should you have any questions or concerns, please call our Consumer Services Department at 1-800-521-2010 in the U.S. or 1-800-267-7377 in Canada, and a service representative will be happy to help you.

**VTECH® Little Learning Pal™** opens a new world of fun learning for children while teaching them a wide range of topics. The learning unit comes with twenty-five double-sided game cards and 8 on board activities, including spelling, matching, math, music, and more.

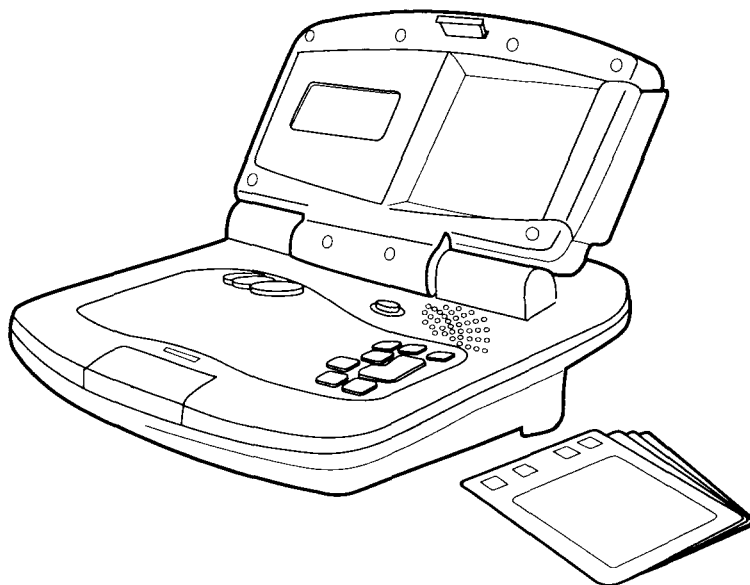

## POWER SOURCE

The **Little Learning Pal™** learning unit operates on 4 “AA” (UM-3/LR6) batteries.

## **BATTERY INSTALLATION**

1. Make sure the unit is **OFF**.
2. To insert batteries, remove the battery cover on the bottom of the unit.
3. Insert 4 "AA" (UM-3/LR6) batteries as illustrated. Make certain that the polarity signs (+,-) are matched correctly.

**WE DO NOT RECOMMEND THE USE OF RECHARGEABLE BATTERIES.**

4. Close the battery cover.

**NOTE:** The use of alkaline batteries is recommended for maximum performance.

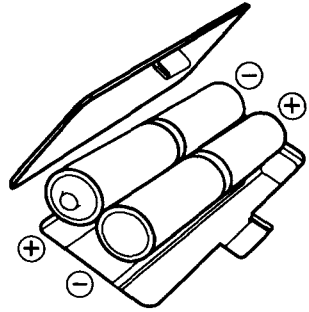

## **BATTERY NOTICE**

- Install batteries correctly observing the polarity (+,-) signs to avoid leakage.
- Do not use rechargeable batteries.
- Do not mix old and new batteries.
- Do not use batteries of different types.
- Remove exhausted or new batteries from equipment when you are not going to use the unit for a long time.
- Do not dispose of batteries in fire.
- Do not attempt to recharge ordinary batteries.
- The supply terminals are not to be short-circuited.

## **TURNING THE UNIT ON**

Turn the unit on by pressing the **ON** button. Choose a card. Insert the card into the window so that the holes slide in first and press firmly. Be sure the card is inserted completely or the unit will not be able to read it.

Depending on which card is inserted, the activities are played either by using the red, yellow, blue and green cursor buttons or by using the keyboard.

## **TURNING THE UNIT OFF**

Turn the unit off by pressing the **OFF** button. If you will not be using the unit for a long period of time, it is best to remove the batteries.

# AUTOMATIC SHUT-OFF

If there is no input into the **VTECH® Little Learning Pal™** for about 5-6 minutes, the unit will automatically shut off to save power.

**NOTE:** If the unit freezes or stops working, follow these steps:

1. Turn the unit **OFF**.
2. Remove the batteries.
3. Let the unit stand for a few minutes, then replace the batteries.
4. Turn the unit **ON**. The unit will now be ready to play again.

If the problem persists, please call our Consumer Services Department at 1-800-521-2010 in the U.S. or 1-800-267-7377 in Canada. and a service representative will be happy to help you.

# CARD STORAGE

All 25 double-sided activity cards can be conveniently stored in the special compartment located on the bottom of the **Little Learning Pal™**.

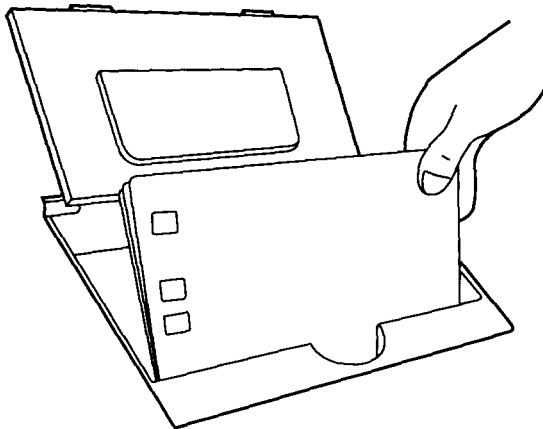

# KEYBOARD DESCRIPTION AND FUNCTIONS

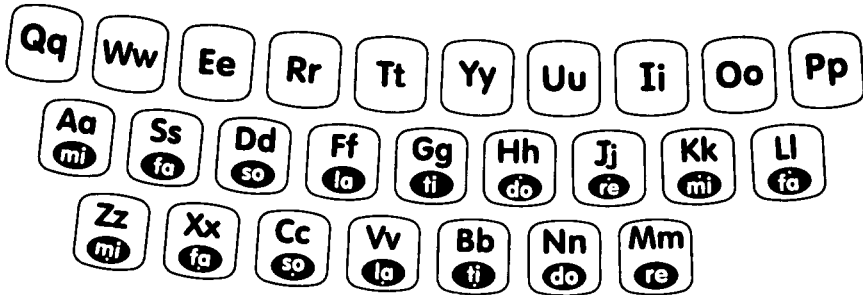
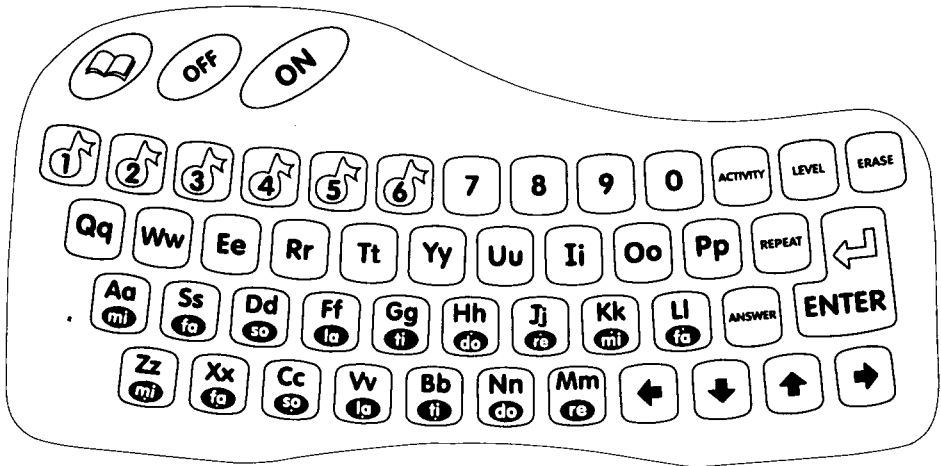

Use the letter keys to type in the correct letters to answer questions.

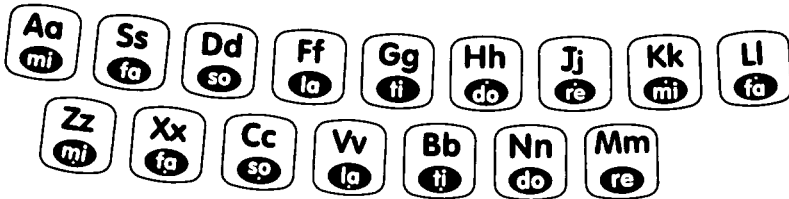

The second and third row of letter keys are also used as music keys and each represents a note for music play.



Use the number keys to type in the correct numbers to answer questions.

## FUNCTION KEYS:



Press this key to turn the unit **ON**.



Press this key to turn the unit **OFF**.



Press this key to select different levels when playing the on board activities only.



Press this key to confirm your answer.



Press this key to erase an answer before pressing the **ENTER** key.



Press this key to learn the answer to a question.



Press this key to repeat the question. Not available in all activities.



Press this key to select the different on board activities.



Press this key to activate the Matchbook function.



Press these keys to answer the questions on the activity cards and to answer questions in the Matchbooks. These keys are also used as cursor keys in all the activities.



# SCORING

The **Little Learning Pal™** will ask four questions for each card. For each correct answer you will earn two stars and 25 points. If you answer all four correctly, you will get ten bonus stars. If you press the **ANSWER** key, you will receive 0 star and 0 point.

**Scoring Table:**

NUMBER OF CORRECT ANSWERS	NUMBER OF REWARD STARS	NUMBER OF REWARD POINTS
0	0 star	0 Point
1	2 stars	25 Points
2	4 stars	50 Points
3	6 stars	75 Points
4	10 stars	100 Points

## LITTLE LEARNING PAL™ ACTIVITY CARDS

The 25 double-sided activity cards cover letters, spelling, numbers, counting, addition, subtraction, object matching, music and much more. Two special cards, #49 and #50, activate 8 on board games in the unit.

### **DESCRIPTION OF CARD ACTIVITIES**

#### **CARD 1, CARD 2 , CARD 3 & CARD 4: LETTER MATCHING**

A question number will appear on the LCD screen. Find that number on the card and match the capital letter to the lower case letter. Press the red, yellow, blue or green cursor key to answer the question.

#### **CARD 5 & CARD 6: LETTER PUZZLE**

A question number will appear on the LCD screen. Find that number on the card and match the two halves of the letter to form a complete letter. Press the red, yellow, blue or green cursor key to answer the question.

### **CARD 7: IDENTIFICATION**

A question number will appear on the LCD screen. Find the number on the card and match each part of the body to its name. Press the red, yellow, blue or green cursor keys to answer the question.

### **CARD 8: MATCHING**

A question number will appear on the LCD screen. Find the number on the card and match the fruit with its name. Press the red, yellow, blue or green cursor keys to answer the question.

### **CARD 9 & CARD 10: MATCHING**

A question number will appear on the LCD screen. Find the number on the card and match each word to the correct number. Press the red, yellow, blue or green cursor keys to answer the question.

### **CARD 11, CARD 12, CARD 13, CARD 14, CARD 15 & CARD 16: BEGINNING LETTERS**

A question number will appear on the LCD screen. Find the number on the card and choose the correct beginning letter for the name of each object. Press the letter keys to answer the question, and press the **ENTER** key to confirm.

### **CARD 17 , CARD 20 & CARD 22: SPELLING**

A question number will appear on the LCD screen. Find the number and corresponding animal picture on the card to spell the name for each animal. The number of dashes for each picture represents how many letters are in the word. Press the letter keys to answer the question, and press the **ENTER** key to confirm.

### **CARD 18 , CARD 19 & CARD 21: SPELLING**

A question number will appear on the LCD screen. Find the number and corresponding object picture on the card to spell the name of the object. The number of dashes for each picture represents how many letters are in the word. Press the letter keys to answer the question, and press the **ENTER** key to confirm.

### **CARD 23: COUNTING**

A question number will appear on the LCD screen. Find the number on the card and count the fish. Press the number keys to answer the question, and press the **ENTER** key to confirm.

### **CARD 24: COUNTING**

A question number will appear on the LCD screen. Find the number on the card and count the objects. Press the number keys to answer the question, and press the **ENTER** key to confirm.

### **CARD 25 & CARD 26: NUMBER PATTERNS**

A question number will appear on the LCD screen. Find the number on the card and fill in the missing number to complete the sequence. Press the number keys to answer the question, and press the **ENTER** key to confirm.

### **CARD 27 , CARD 28 & CARD 33: ADDITION**

A question number will appear on the LCD screen. Find the number on the card and solve each equation. Press the number keys to answer the question, and press the **ENTER** key to confirm.

### **CARD 29 & CARD 30: MISSING NUMBER**

A question number will appear on the LCD screen. Find the number on the card and fill in the missing number to complete the sequence. Press the number keys to answer the question, and press the **ENTER** key to confirm.

### **CARD 31 , CARD 32 & CARD 34: SUBTRACTION**

A question number will appear on the LCD screen. Find the number on the card and solve each equation. Press the number keys to answer the question, and press the **ENTER** key to confirm.

### **CARD 35 & CARD 36: OPPOSITES**

A question number will appear on the LCD screen. Find the number and corresponding object picture on the card and match them to the opposite picture on the right of the card. Press the red, yellow, blue or green cursor keys to answer the question.

### **CARD 37: WHAT GOES TOGETHER**

A question number will appear on the LCD screen. Find the number on the card and match the objects on the left to the objects on the right that belong together. Press the red, yellow, blue or green cursor keys to answer the question.

### **CARD 38: PUZZLE PIECES**

A question number will appear on the LCD screen. Find the number on the card and match the missing pieces to the corresponding objects. Press the red, yellow, blue or green cursor keys to answer the question.

### **CARD 39: MATCHING**

A question number will appear on the LCD screen. Find the number on the card. Follow the line and match each balloon to a present. Press the red, yellow, blue or green cursor keys to answer the question.

### **CARD 40: MATCHING**

A question number will appear on the LCD screen. Find the number on the card. Follow the path and match each woman with a ball of yarn. Press the red, yellow, blue or green cursor keys to answer the question.

### **CARD 41: WHERE DO I LIVE**

A question number will appear on the LCD screen. Find the number on the card and match each animal with its home. Press the red, yellow, blue or green cursor keys to answer the question.

### **CARD 42: FOOD GROUPS**

A question number will appear on the LCD screen. Find the number on the card and match the two foods that belong in the same food group. Press the red, yellow, blue or green cursor keys to answer the question.

### **CARD 43: WHAT GOES TOGETHER**

A question number will appear on the LCD screen. Find the number on the card and match the two objects that are related. Press the red, yellow, blue or green cursor keys to answer the question.

### **CARD 44: MISSING OBJECT**

A question number will appear on the LCD screen. Find the number on the card and fill in the missing object to complete the sequence. Press the red, yellow, blue or green cursor keys to answer the question.

### **CARD 45 , CARD 46 , CARD 47 & CARD 48: PLAY ALONG**

Press the music keys in the same order as they appear on the card to hear the songs or to make your own songs.

### **CARD 49 & CARD 50: ON BOARD ACTIVITY CARDS**

After you insert one of these card, a main menu screen will appear and ask you to select one of the on board activities. If you insert CARD 49, you may choose activities 1-4; for CARD 50, you may choose activities 5-8.



**NOTE:** If you lose the number 49/50 card, you may enter the following secret codes to activate the board activities. Make sure that no other cards are inserted when entering the code.

For Card 49 type:  CARD49

For Card 50 type:  CARD50

The secret codes can also be found on the back of the Card Storage area.

# 8 ON BOARD ACTIVITIES DESCRIPTION

## 1: FOLLOW THIS

The character on the screen will point up, down, left, and right. Remember the movements of the character and then use the cursor keys  to repeat them.



## 2: ALPHABET ORDER

A sequence of letters will show on the screen. You have to fill in the missing letter(s). You need to press the **ENTER** key to confirm your answer.

A B            A B C    A B C    A B C  
                  ?           ? E F    D E F

## 3: MAZE CHALLENGE

Use the cursor keys  to escape from the maze within the time limit. When the game starts, a square will flash to indicate the starting position, then an arrow will flash to show the exit.



## 4: NUMBER ORDER

A sequence of numbers will show on the screen. You have to fill in the missing number(s). You need to press the **ENTER** key to confirm your answer.

12 14            12 14    12 14  
                  16 ??    16 18

### 5: FIND THE SIGN

Objects will show on the screen. Then the equal, greater than, and less than signs will display between the objects. You need to select the correct sign by pressing the **ENTER** key.

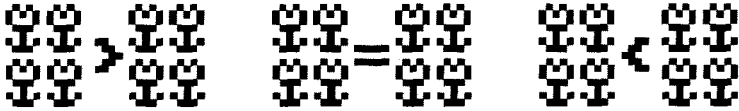

### 6: MATCHING SHAPES

Several shapes will show on the screen. You need to match the shapes. Use the cursor keys  $\leftarrow \rightarrow \uparrow \downarrow$ , to pick the shape you want to match. Press the **ENTER** key to confirm. The shape will have an underline and stop flashing. Use the cursor keys to select the matching shape and press the **ENTER** key to confirm. After confirming the matching shapes, the selected pair will flash together once and disappear. Continue to select objects until they are all gone.



### 7: FIND THE SHAPES

Some shapes will show on the screen for a few seconds. Then the shapes will be covered up. A target shape will appear in the upper right of the screen. You need to find the hidden shape that matches the target shape by using cursor keys  $\leftarrow \rightarrow \uparrow \downarrow$  and pressing the **ENTER** key. All the shapes will be uncovered when you press the **ANSWER** key.

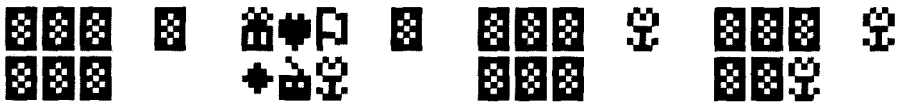

## 8: MUSIC LIBRARY

There are 6 built-in songs. Choose a song by pressing the 1-6 number keys, using the cursor keys  or press the **ENTER** key when the number is flashing.

1. I've Been Working on The Railroad
2. She'll Be Comin "Round the Mountain
3. A Bicycle Built For Two
4. Row, Row, Row Your Boat
5. Frère Jacques
6. On Top Of Old Smoky



## HOW TO USE THE MATCHBOOK

To use the Smart Start Matchbooks, press the **BOOK** key  on the keyboard. Input the code number of the matchbook and press the **ENTER** key. A question number will appear on the LCD screen. Find that question in the book. Press the red, yellow, blue or green cursor keys to answer the question.

## CARE AND MAINTENANCE

1. Keep the unit clean by wiping it with a slightly damp cloth.
2. Keep the unit out of direct sunlight and away from any heat source.
3. Remove the batteries when the unit is not in use for an extended period.
4. Do not drop the unit on hard surfaces or get it wet.

**IMPORTANT NOTE:**

Creating and developing electronic learning aids is accompanied by a responsibility that we at **VTECH®** take very seriously. We make every effort to ensure the accuracy of the information which forms the value of our products. However, errors sometimes can occur. It is important for you to know that we stand behind our products and encourage you to call our Consumer Services Department at 1-800-521-2010 in the U.S. or 1-800-267-7377 in Canada with any problems and/or suggestions that you might have. A service representative will be happy to help you.

**Note:**

This equipment generates and uses radio frequency energy and if not installed and used properly, that is in strict accordance with the manufacturer's instructions, it may cause interference to radio and television reception. It has been type tested and found to comply within the limits for a class B computing device in accordance with the specifications in Subpart J of Part 15 FCC Rules, which are designed to provide reasonable protection against such interference in a residential installation. However, there is no guarantee that interference will not occur in a particular installation. If this equipment does cause interference to radio or television reception, which can be determined by turning the equipment off and on, the user is encouraged to try to correct the interference by one or more of the following measures:

- reorient the receiving antenna
- relocate this product with respect to the receiver
- move this product away from the receiver